

# Temperature metering KTY84-1xx (°C/°F)

- Standard: 2 setpoints, min/max memory, optional analogue output
- Mounting into panels with thickness up to 50 mm
- Allows to be placed side by side in grid and mosaics system

**48x24**

**8888**

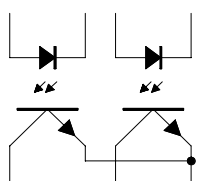
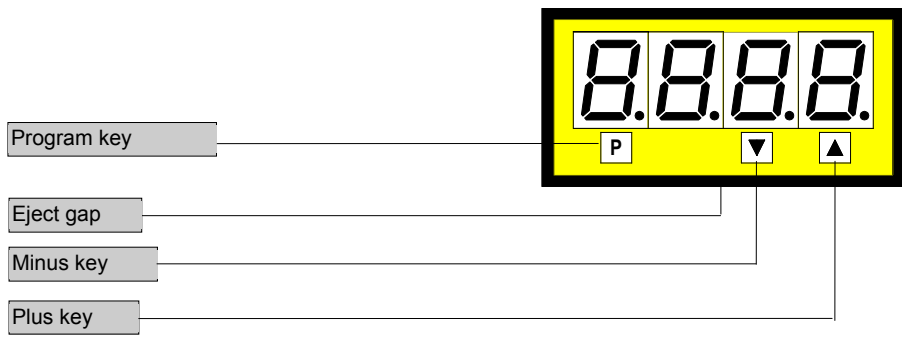

ORDER NUMBER OF TYPE

**PTE 4.504.7782B**

2-wire  
(0,0...+300,0°C)

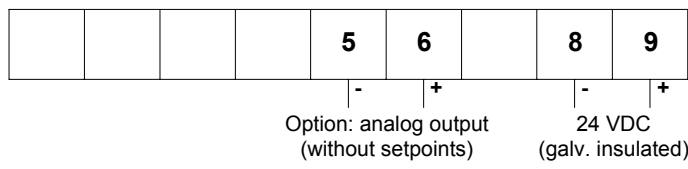
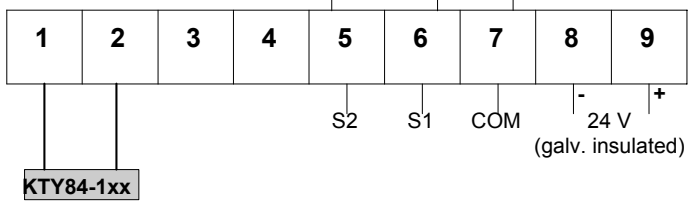

## Options

- green LED
- Protection IP54 (standard: plug in terminal)
- Analog output 0-10 VDC - (12 bit)
- Analog output 0-20 mA/load 500 Ω
- Analog output 4-20 mA/load 500 Ω
- With analog output setpoints S1 and S2 are not available!**
- Setpoint as open emitter
- Dimension strip selectable (8 characters max.)
- 4-wire on demand

# Technical data

<b>Dimensions</b>	Housing	48 x 24 x 90 mm, including screw terminal
	Assembly cut out	45.0 <sup>+0.6</sup> x 22.2 <sup>+0.3</sup> mm
	Fastening	special quick plastic clamp proper to fix in wall thickness up to 50 mm
	Housing material	PC/ABS-blend, colour black, UL94V-0
	Protective system	at the front IP40 connection IP00
	Weight	approx. 75 g
	Connection	at the rear side via plug in connector up to 1.5 mm <sup>2</sup>
<b>Input</b>	KTY84	2 wire
	Measuring range	0.0...+300.0°C (32.0...572.0°F)
	Resolution	0.1°C
	Sensor current	approx. 1 mA
<b>Output</b>	Open collector	2 outputs supply by customers ( $U_B=5-40$ V/ $I_{max}=100$ mA for $U_{CE sat}$ )
	Analogue output	0-10 VDC (12 bit)
		0-20 mA/load 500 Ohm (12 bit) 4-20 mA/load 500 Ohm (12 bit)
<b>Accuracy</b>	Resolution	0.1°C
	Measuring fault	+/-4°C, +/- 5 Digit (0...200°C), +/-7°C, +/- 5 Digit (> 200°C)
	Temp. drift	100 ppm/K
	Measuring principle	voltage/frequency converter
<b>Power unit</b>	Supply voltage	24 VDC +/-10 % galvanic insulated
	Power consumption	approx. 2 VA
<b>Indication</b>	Display	LED with 7 segments, 10 mm high, red 4-digit = indication 9999
	Overflow	indication of 4 transversal bars
	Indication time	from 0.2 up to 10.0 seconds adjustable
<b>Ambient conditions</b>	Working temperature	0 up to + 60 °C
	Store temperature	-20 up to + 80 °C

## Housing:

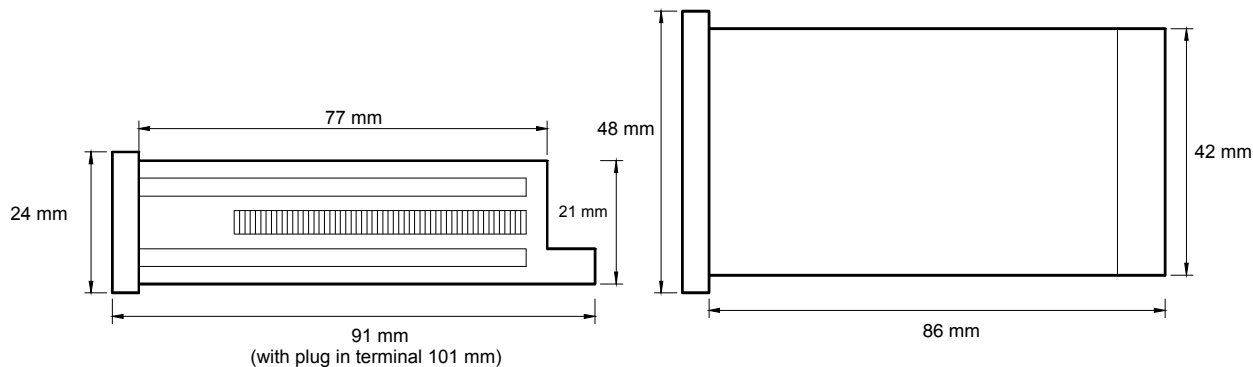

### CE-sign

For unlimited use of the instrument within the directives for electromagnetic compatibility 89/336/EC measuring wires have to be used with shielded cable and cable's shield connected to earth ground at one end only.

# Connection diagram, programming, remarks

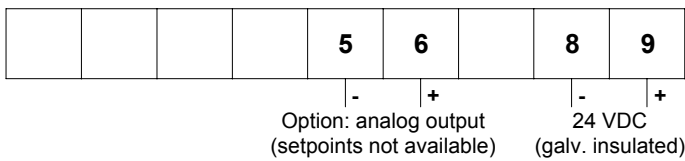
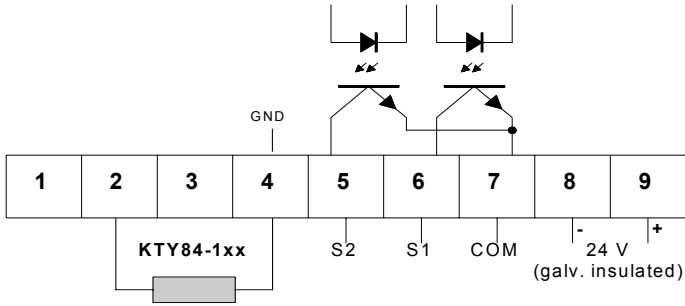

## Setting

1. Connect the instrument according to the wiring diagram.
2. After power on, the instrument runs into a lamp test and returns back to the standard mode.
3. Pressing the **P**-key enters the program mode with indication of "P2" on the display.
4. Pressing the **P**-key and **▲**-key simultaneously steps through the different program numbers .
5. Pressing **▲** or **▼**-key shows the current values.
6. To change values use **▼**- or **▲**-key.
7. Otherwise the remaining values will be memorized automatically 7 seconds after the last touch of key with leaving program mode.

## Additional key-functions in standard-mode for indication of min/max values.

Simultaneously pressing of **▼** and **▲** key deletes and actualizes min/max-memory.  
**▲** key enters max-memory.  
**▼** key enters min-memory.

## Instructions

After power on the instrument with his inbuilt microcontroller starts with an initial program activating lamp test and readout of memorized parameters in an EEPROM.

The following diagrams are showing the switching operation of PVE4 open collector outputs, the hysteresis is free programmable. There are two kinds of operation:

### Example: operation current

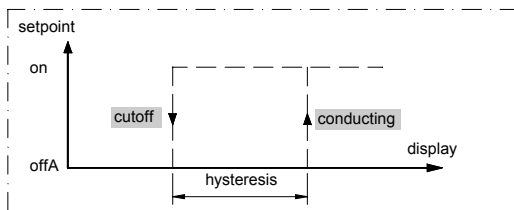

### Example: quiescent current

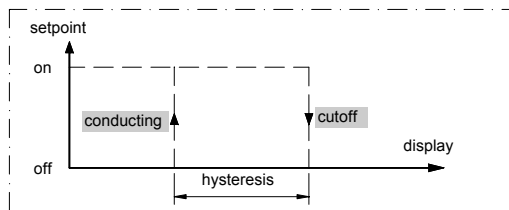

Operation current means that the open collector will be conducted if reaching the adjusted setpoint.

Quiescent current means that the open collector will be cutoff if reaching the adjusted setpoint.

# Operation, setting instructions

subject to technical alteration – status 02/2006 - PTE4K847GB.DOC

## Program table 1

Program Number (PN)	Function	Remark	Display	Basic parameters after reset
2	Sensor and line balancing	Temperature is displayed	0 to +/-20.0	0.0
3	Selection between °C or °F	Celsius=0 / Fahrenheit=1	0/1	0
4	Input of display time	Display time = measuring time Method of measurement integrating	0.2 to 10.0 seconds	1.0
5	Input of final value for analog output	Option	-999 to +9999	500.0
6	Input of offset for analog output	Option	-999 to +9999	0.0

## Program table 2 (Setting points)

S1 PN	S2 PN	Function	Display	Basic parameters after reset
61	66	Setpoint	-999 to +9999	100.0/150.0
62	67	Hysteresis	0 to +9999	0.1/0.1
63	68	Quiescent current	0	-
		Operating current	1	1/1

## Example for programming

**Temperature sensor:** KTY84-1xx  
**Connection:** 2-wire  
**Display:** 0.0 bis 70.0°C  
**Display refresh time:** 2.0 seconds  
**Setpoints:** S1 ==> 30.0 and quiescent current  
 open collector conducting = 28.0 ==>hysteresis 2.0  
 S2 ==> 70.0 and operating current  
 open collector cut off = 40.0 ==>hysteresis 30.0  
**Analog output:** 0 V output ==> display 0.0 ==> 0.0°C  
 (no setpoints) 10 V output ==> display 70.0 ==> 70.0°C

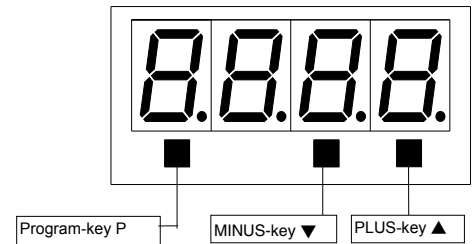

The basic adjustments concerning to the following program example are the ground parameters after a total reset occurring through a power on with pressing **P**-key (see previous page).

### Program advices:

Pressing the **P**-key enters **always** the program mode with program number **2**. The **P2** begins to blink in change with the current value after 3 seconds. After further 4 seconds the system leaves the program mode and goes to the standard mode. In program mode pressing **▼** or **▲** -key selects the current values which are free scalable with both the keys. All the other parameters will be memorized automatically after leaving program mode.

### Programming

Switch power on!

Lamp test

Standard mode

Set KTY84 simulator to 0°C.  
The indication value depends on the used cable length.

To program number 2 with **P**.

To memorized value with **▼** or **▲**.

Sensor and line balancing.

To program number 3 with **P** and **▲**.

To memorized value with **▼** or **▲**.

To program number 4 with **P** and **▲**.

# Example for programming

To memorized value with ▼ or ▲.

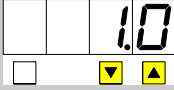

Set display time



The following programming steps are necessary for the setpoint programming of S1 and S2 only.

To program number 61 with P and ▲.



To memorized value with ▼ or ▲.



Set free scalable value for setpoint S1.



To program number 62 with P and ▲.



To memorized value with ▼ or ▲.

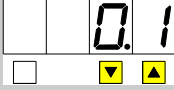

Set hysteresis for S1.



To program number 63 with P and ▲.



To memorized value with ▼ or ▲.

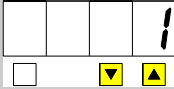

Set quiescent current.

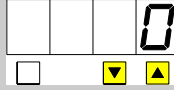

To program number 66 with P and ▲.

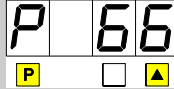

To memorized value with ▼ or ▲.



Set free scalable value for setpoint S2.



To program number 67 with P and ▲.



To memorized value with ▼ or ▲.

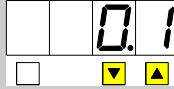

Set hysteresis for S2.



To program number 68 with P and ▲.



To memorized value with ▼ or ▲.

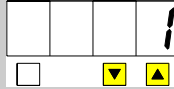

Set operating current.

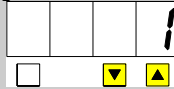

**Programming finished.**

All programmed values are memorized after 7 seconds. Jumps back into standard mode automatically.

The program numbers 5 and 6 are available with option analogue output only.

To program number 5 with P and ▲.

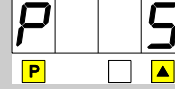

To memorized value with ▼ or ▲.



Set free scalable final value for analog output.

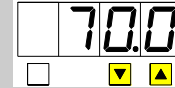

To program number 6 with P and ▲.

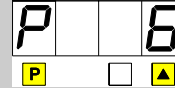

To memorized value with ▼ or ▲.

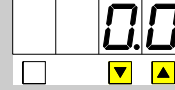

**Programming finished.**

All programmed values are memorized after 7 seconds. Jumps back into standard mode automatically.